

ONESTO[®]

www.onesto.cn

ONESTO ELECTRIC Co., Ltd.

Room 1601-1603, Yueshang Mansion,
No.2088 Wenzhou Avenue, Wenzhou,
China. 325000

TEL. 0086 577 8676 0560
FAX. 0086 577 8676 0580
E-MAIL. onesto@onestoelectric.com



© 2021-2022 Zhejiang ONESTO Electric Co., Ltd. All rights reserved.
We reserve the right to amend any information included in this publication without prior notice. Such modifications, along with errors and printing errata, shall not constitute grounds for compensation.

2021.12.10



**QUALITY
HAS A NAME.**

2022-2023

ONESTO[®]



Company Profile

As an active player in electrical manufacturing industry over 15 years, **ONESTO** is committed to providing quality assured products for application in power distribution, industrial control and new energy etc.

ONESTO is a name of quality that focuses on customer's safety and satisfaction. The company is operated under ISO9001:2015 Quality Management System. All the products are manufactured in conformity with BE,EN,IEC international standards and acquired CE,CB,TUV,Semko, KEMA-KEUR certificates.

ONESTO is undertaking intelligent manufacturing. The factory set up advance automated assembly and testing production line to secure high precision parts dimension, accurate automated assembly, outstanding technical performance and efficient production capacity. Onesto introduced advance ERP system to achieve full quality tracing for each step of raw material incoming, production process and delivery.

ONESTO always pursues constant product innovation to offer customers with comprehensive selection for commercial, industrial, residential project where quality is essential. Onesto owns independent intellectual property rights for its product range including domestic and international patents.

Today, customers over 50 countries are benefited from **ONESTO** products and solution for its reliable protection of electrical systems. As a well recognized partner with renowned companies around the world, **ONESTO** is ready to create new value and competitive advantages with partners for mutual continuously development.

Factory Tour



IRS-P02C



FEATURES

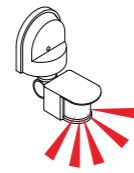

180°Detection



Max.2-12m Detection Range(adjustable)

TECHNICAL DATA

Type	IRS-P02C
Power Source	220~240V/AC
Power Frequency	50/60Hz
Time Setting	min: 10sec±3sec max: 7min±3min
Detection Moving Speed	0.6-1.5m/s
Rated Load	1200W (incandescent lamp) 300W(energy-saving lamp)
Ambient Light	10-2000LUX (adjustable)
Working Temperature	-20°C to +40°C
Mounting	Wall mounted
Installation Height	1.8m~2.5m
Protection Degree	IP44/Class II

DIMENSION

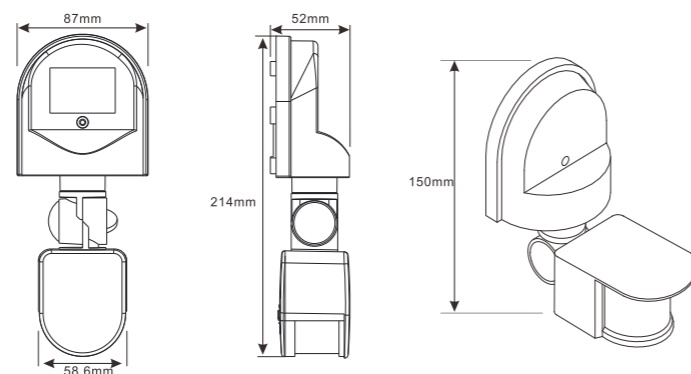

FOR OTHER VERSIONS:
Please consult ONESTO or local distributor.

IRS-P06



FEATURES

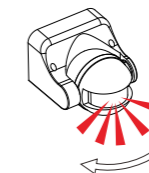

180°Detection



Max.12m Detection Range

TECHNICAL DATA

Type	IRS-P06
Power Source	220~240V/AC
Power Frequency	50/60Hz
Time Setting	min: 10sec±3sec max: 7min±3min
Detection Moving Speed	0.6-1.5m/s
Rated Load	1200W (incandescent lamp) 300W(energy-saving lamp)
Ambient Light	10-2000LUX (adjustable)
Working Temperature	-20°C to +40°C
Mounting	Wall mounted
Installation Height	1.8m~2.5m
Protection Degree	IP44/Class II

DIMENSION

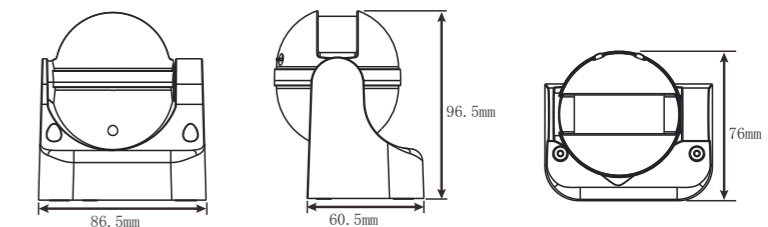

IRS-P15C



FEATURES

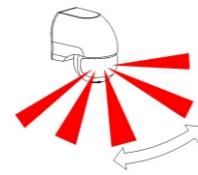

180° detection



Max.12m Detection Range(adjustable)

TECHNICAL DATA

Type	IRS-P15C
Power Source	220~240V/AC
Power Frequency	50/60Hz
Time Setting	min: 10sec±3sec max: 7min±2min
Detection Moving Speed	0.6-1.5m/s
Rated Load	800W (incandescent lamp) 400W(energy-saving lamp)
Ambient Light	3-2000LUX (adjustable)
Working Temperature	-20°C to +40°C
Mounting	Wall mounted
Installation Height	1.8m~2.5m
Protection Degree	IP54/Class II

DIMENSION

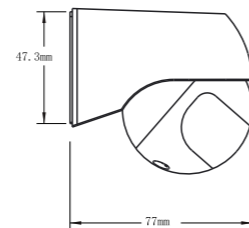
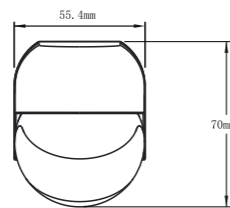

IRS-P14



FEATURES



360° detection

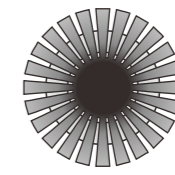

Max.6m Detection Range

TECHNICAL DATA

Type	IRS-P14
Power Source	220~240V/AC
Power Frequency	50/60Hz
Time Setting	min: 10sec±3sec max: 7min±3min
Detection Moving Speed	0.6-1.5m/s
Rated Load	800W (incandescent lamp) 400W(energy-saving lamp)
Ambient Light	10-2000LUX (adjustable)
Working Temperature	-20°C to +40°C
Mounting	Ceiling flush mounted
Installation Height	2.2m~4m
Protection Degree	IP20/Class II

DIMENSION

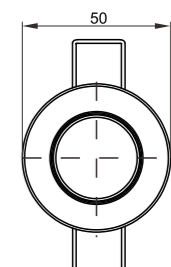
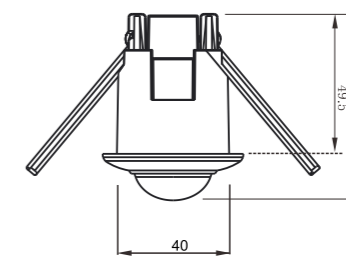

FOR OTHER VERSIONS:
Please consult ONESTO or local distributor.

IRS-P17A1



FEATURES



360° detection

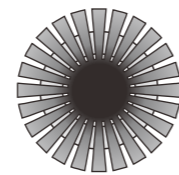

Max.6m Detection Range

TECHNICAL DATA

Type	IRS-P17A1
Power Source	220~240V/AC
Power Frequency	50/60Hz
Time Setting	min: 10sec±3sec max: 7min±2min
Detection Moving Speed	0.6-1.5m/s
Rated Load	1200W (incandescent lamp) 300W(energy-saving lamp)
Ambient Light	5-2000LUX (adjustable)
Working Temperature	-20°C to +40°C
Mounting	Ceiling flush mounted
Installation Height	2.2m~4m
Protection Degree	IP20/Class II

DIMENSION

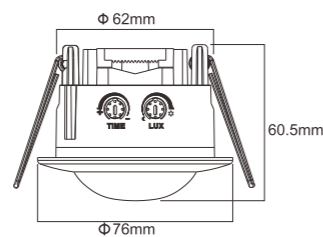

IRS-P19A



FEATURES



360° detection

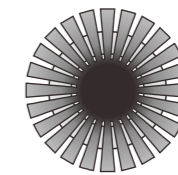

Max.6m Detection Range

TECHNICAL DATA

Type	IRS-P19A
Power Source	220~240V/AC
Power Frequency	50/60Hz
Time Setting	min: 10sec±3sec max: 7min±2min
Detection Moving Speed	0.6-1.5m/s
Rated Load	1200W (incandescent lamp) 300W(energy-saving lamp)
Ambient Light	3-2000LUX (adjustable)
Working Temperature	-20°C to +40°C
Mounting	Ceiling surface mounted
Installation Height	2.2m~4m
Protection Degree	IP20/Class II

DIMENSION

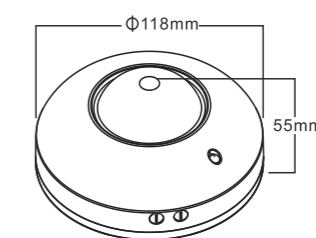

FOR OTHER VERSIONS:
Please consult ONESTO or local distributor.

IRS-P30B



FEATURES



360° detection

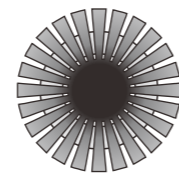

Max.8m Detection Range

TECHNICAL DATA

Type	IRS-P30B
Power Source	220~240V/AC
Power Frequency	50/60Hz
Time Setting	min: 10sec±3sec max: 15min±3min
Detection Moving Speed	0.6-1.5m/s
Rated Load	1200W (incandescent lamp) 300W(energy-saving lamp)
Ambient Light	10-2000LUX (adjustable)
Working Temperature	-20°C to +40°C
Mounting	Ceiling flush mounted
Installation Height	2.2m~4m
Protection Degree	IP20/Class II

DIMENSION

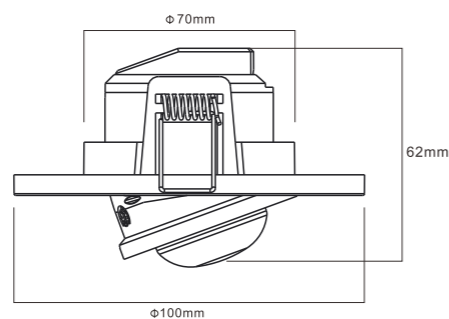

IRS-P36B



FEATURES



360° detection

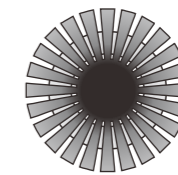

Max.6m Detection Range

TECHNICAL DATA

Type	IRS-P36B
Power Source	220~240V/AC
Power Frequency	50/60Hz
Time Setting	min: 10sec±3sec max: 7min±2min
Detection Moving Speed	0.6-1.5m/s
Rated Load	800W (incandescent lamp) 400W(energy-saving lamp)
Ambient Light	10-2000LUX (adjustable)
Working Temperature	-20°C to +40°C
Mounting	Ceiling surface mounted
Installation Height	2.2m~4m
Protection Degree	IP20/Class II

DIMENSION

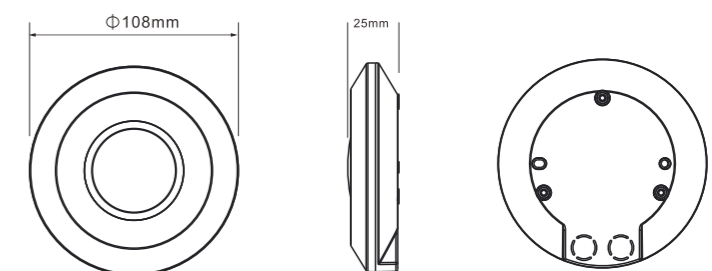

FOR OTHER VERSIONS:
Please consult ONESTO or local distributor.

IRS-P41A

NEW 2 in 1 Edition 800W



FEATURES



360° detection

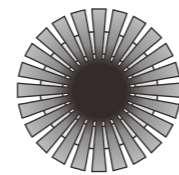

Max.8m Detection Range

TECHNICAL DATA

Type	IRS-P41A
Power Source	220~240V/AC
Power Frequency	50/60Hz
Time Setting	min: 10sec±3sec max: 7min±2min
Detection Moving Speed	0.6-1.5m/s
Rated Load	800W (incandescent lamp) 400W(energy-saving lamp)
Ambient Light	10-2000LUX (adjustable)
Working Temperature	-20°C to +40°C
Mounting	Ceiling surface or flush mounted
Installation Height	2.2m~4m
Protection Degree	IP20/Class II

DIMENSION

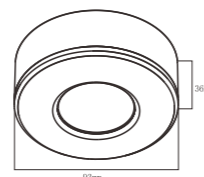
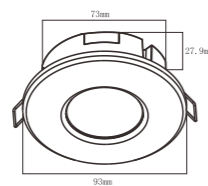

FOR OTHER VERSIONS:
Please consult ONESTO or local distributor.